

# Progress report on 3GPP





## 3GPP UE IMS CC Conformance Testing and TTCN3

Shicheng Hu **PTCC**  
[shicheng.hu@etsi.org](mailto:shicheng.hu@etsi.org)  
31 May – 2 June 2006  
Berlin Germany  
T3UC#3

A GLOBAL INITIATIVE

1



## Contents

- Who are 3GPP RAN5
- What have they done
- Who are RAN5 clients
- MCC task force 160
- IMS CC test
- Plan ahead

A GLOBAL INITIATIVE

2

## Progress report on 3GPP

Standards for Business



### 3GPP TSG RAN-WG5 (1)

- **3GPP is the 3<sup>rd</sup> generation partnership project**
  - 6 OPs (organizational partners)
  - 8 MRPs (market representation partners)
  - PCG (Coordination group) + 4 TSG (technical specification groups)
  - Project going on for next 10 years
- **RAN5 responsible for UE (User Equipment - mobile) conformance test within 3GPP**
- **RAN5 leadership**

RAN5 Chair:	Phil Brown, NTT DoCoMo
Vice Chair:	Carolyn Taylor, Motorola
Vice Chair:	Bosco Choi, Anritsu
MCC Support:	Stoyan Baev, ETSI
TF 160 Leader:	Shicheng Hu, ETSI

A GLOBAL INITIATIVE

3

Standards for Business



### 3GPP TSG RAN-WG5 (2)



- **RAN5 having 4 meetings / year**
  - Meeting duration: a whole week
- **Each meeting has 60 - 70 participants from 40 companies**
- **Two sub-working groups**
  - Signaling / protocol conformance test
  - RF conformance test
- **11 test specifications produced for all 3GPP radio technologies, for all releases and for all radio frequency bands**
- **12 active WI (work items) + 4 maintenance WI**

A GLOBAL INITIATIVE

4

## Progress report on 3GPP

Standards for Business





### Test specifications for 3G deployment

- **RAN5 clients**
  - GCF (Global Certification Forum)
  - PTCRB (PCS Type Certification Review Board)
    - GCF + PTCRB are the major clients for W-CDMA (FDD) & GSM/GPRS test specs
  - TDIA (TD-SCDMA Industry Alliance)
    - TDIA is the major clients for TD-SCDMA (LCR TDD) test specs
- **RAN5 WIs have clearly mapping to GCF WI**
- **Test scope is concentrated on the features, functions and core requirements to be soon deployed and the UE interoperability required**

5

Standards for Business





### Protocol / signalling Test

- **Protocol / signalling test is the most difficult & time-consumed**
- **RAN5 working approach**
  - Detailed test spec in the prose
  - Organize a task force to implement in TTCN
- **Voluntary contributions for the prose specs**
- **Funded MCC task force 160 responsible for the TTCN implementations**
- **All radio access test written in TTCN2**
- **500 test cases running on 4 platforms**
  - Covering R99, (Rel-4,) Rel-5, Rel6
- **Used for UE certifications**

6

## Progress report on 3GPP





### IMS CC Conformance Testing

- 3GPP IMS (IP multimedia subsystem) will be deployed
- RAN5 needs to provide conformance testing for IMS Call Control Protocol
- Scope
  - 3GPP SIP Signaling required to initiate a basic SIP session
  - Core requirements in TS 24.229
- 3GPP ATS is required
- TTCN3 is used for the test specification

A GLOBAL INITIATIVE

7



### TTCN3 New Comers

- MCC task 160 responsible for IMS CC ATS
  - TTCN3 new comers
- ATS to be developed as radio bearer agnostic
- To be executed through radio interface
- Test shall support IPv6 and IPv4
- Test shall support IPsec
  - Cater for UE supporting early IMS security
- SigComp applied
- Test cases to be repeated in ISIM and USIM configuration
- Test model to be extendable to support different radio access technologies

A GLOBAL INITIATIVE

8

# Progress report on 3GPP

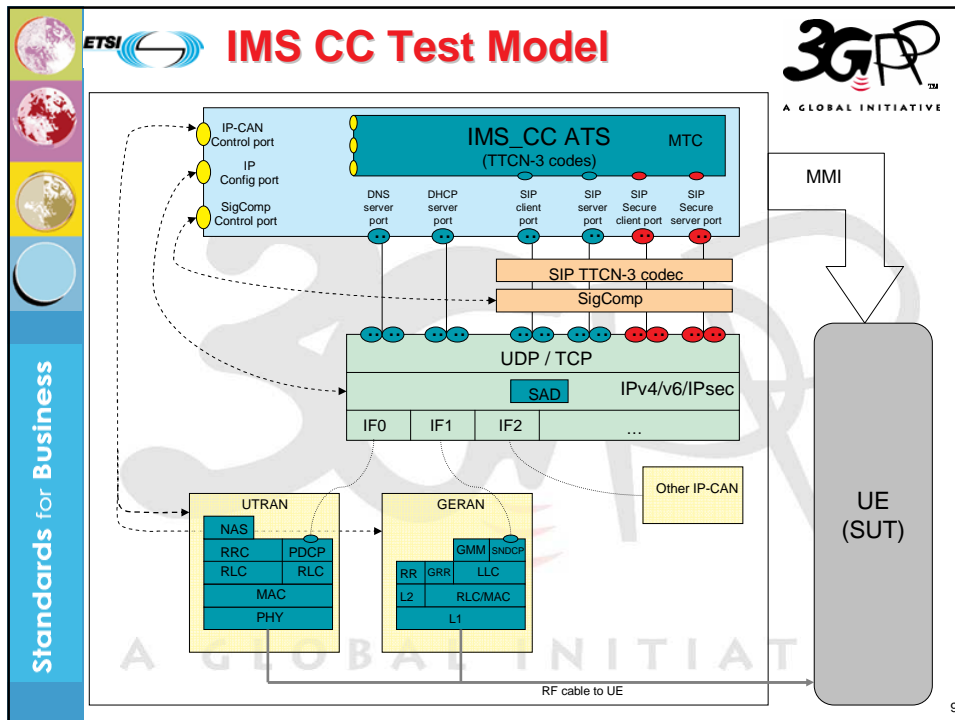

**Plan Ahead and Milestone**

- **ATS containing 40 test cases**
- **Initial ATS to be delivered in Sept 06 for verification**
- **Target to the 3GPP approval in March 07 as milestone**
- **Upgrade from Rel-5 to Rel-6 by end of 2007**

The slide is branded with ETSI and 3GPP logos, and includes the text "Standards for Business" and "A GLOBAL INITIATIVE".